

Thermal Monocular Camera

User's Manual









Foreword

General

This manual introduces the functions and operations of Thermal Monocular Camera (hereinafter referred to as "the Camera"). Read carefully before using the device, and keep the manual safe for future reference.

Safety Instructions

The following signal words might appear in the manual.

Signal Words	Meaning
 DANGER	Indicates a high potential hazard which, if not avoided, will result in death or serious injury.
 WARNING	Indicates a medium or low potential hazard which, if not avoided, could result in slight or moderate injury.
 CAUTION	Indicates a potential risk which, if not avoided, could result in property damage, data loss, reductions in performance, or unpredictable results.
 ESD	Electrostatic Sensitive Devices. Indicates a device that is sensitive to electrostatic discharge.
 ELECTRIC SHOCK	Indicates dangerous high voltage. Take care to avoid coming into contact with electricity.
 TIPS	Provides methods to help you solve a problem or save time.
 NOTE	Provides additional information as a supplement to the text.

Revision History

Version	Revision Content	Release Time
V2.0.0	Updated the contents of configuration.	August 2024
V1.0.1	Updated the figures of device.	April 2023
V1.0.0	First release.	September 2022

Privacy Protection Notice

As the device user or data controller, you might collect the personal data of others such as their face, fingerprints, and license plate number. You need to be in compliance with your local privacy protection laws and regulations to protect the legitimate rights and interests of other people by implementing measures which include but are not limited: Providing clear and visible identification to inform people of the existence of the surveillance area and provide required contact information.

About the Manual

- The manual is for reference only. Slight differences might be found between the manual and the

product.

- We are not liable for losses incurred due to operating the product in ways that are not in compliance with the manual.
- The manual will be updated according to the latest laws and regulations of related jurisdictions. For detailed information, see the paper user's manual, use our CD-ROM, scan the QR code or visit our official website. The manual is for reference only. Slight differences might be found between the electronic version and the paper version.
- All designs and software are subject to change without prior written notice. Product updates might result in some differences appearing between the actual product and the manual. Please contact customer service for the latest program and supplementary documentation.
- There might be errors in the print or deviations in the description of the functions, operations and technical data. If there is any doubt or dispute, we reserve the right of final explanation.
- Upgrade the reader software or try other mainstream reader software if the manual (in PDF format) cannot be opened.
- All trademarks, registered trademarks and company names in the manual are properties of their respective owners.
- Please visit our website, contact the supplier or customer service if any problems occur while using the device.
- If there is any uncertainty or controversy, we reserve the right of final explanation.

Important Safeguards and Warnings

This section introduces content covering the proper handling of the device, hazard prevention, and prevention of property damage. Read carefully before using the device, and comply with the guidelines when using it.

Transportation Requirements



- Transport the Camera within the allowed humidity and temperature conditions.
- Do not fall, squeeze, violently vibrate or immerse the device in liquid when transporting. Gently pick and place the Camera when moving, prevent the internal equipment becoming damaged or cable connection becoming loose.
- Do not transport the Camera without package. Use the factory default package or material of equal quality to pack the Camera when transporting it, otherwise the Camera can become easily damaged.

Storage Requirements



- Store the Camera within the allowed humidity and temperature conditions.
- Do not place the device in a humid, dusty or extremely hot or cold site that has strong electromagnetic radiation or unstable illumination.
- Do not squeeze, violently vibrate or immerse the device in liquid.
- Do not mechanically vibrate or crash when storing.
- Store the Camera in a ventilated place that has no strong electromagnetic radiation.
- For long-term storage of the battery, make sure that it is fully charged every half year to ensure the battery quality. Otherwise, damage may occur.

Operation Requirements



- Prevent liquid from flowing into the Camera to avoid damage to the internal components.
- Do not stuff foreign materials into the Camera to prevent a short circuit which could result in the Camera being damaged or people becoming injured.
- Do not expose the device to high electromagnetic radiation or dusty environments.
- Do not aim the lens at the sun or any other bright light.
- Improper use or replacement of the battery may result in explosion hazard.
- Do not charge other battery types with the supplied charger. Confirm there is no flammable material within 2 m of the charger during charging.
- Make sure that the plug is properly connected to the power socket.
- Do not connect multiple devices to one power adapter, to avoid over-heating or fire hazards caused by overload.
- If smoke, odor, or noise arises from the device, immediately turn off the power, unplug the power cable, and contact the service center.



- Do not dismantle the Camera. The internal components can only be repaired by a qualified professional. Dismantling it without professional assistance might cause water seeping in or might result in the Camera producing poor quality images.
- Operating temperature: $-20\text{ }^{\circ}\text{C}$ to $+50\text{ }^{\circ}\text{C}$ ($-4\text{ }^{\circ}\text{F}$ to $+122\text{ }^{\circ}\text{F}$), and the operating humidity shall be 95% or less.

Maintenance and Repair Requirements



DANGER

- Prevent liquid from flowing into the Camera to avoid damage to the internal components. In case the liquid enters the Camera, immediately stop using the Camera, cut off the power, and disconnect all the cables, and then contact your local customer service center.
- Use the accessories regulated by the manufacturer. The Camera should be maintained by qualified professionals.
- Make sure to cut off the power before cleaning the Camera, to prevent electric shock.



WARNING

If the Camera malfunctions, contact your local customer service center. Do not dismantle the Camera.



- Clean the Camera body with a piece of soft dry cloth. For any dirt that is hard to remove, pick up a piece of clean and soft cloth, dip it into a little neutral detergent and gently wipe the dust away. After that, wipe away all the remaining liquid on the Camera with another dry cloth. Never use volatile solvents such as alcohol, benzene and thinner, or cleaners that are strong and abrasive. Otherwise, the Camera's surface coating will be damaged and its working performance will be encumbered.
- Save the factory package of the Camera. When the Camera malfunctions, pack the Camera with the factory package and send to the dealer.

Table of Contents

Foreword	I
Important Safeguards and Warnings.....	III
1 Product Introduction	1
1.1 Overview	1
1.2 Functions	1
2 Structure	2
2.1 Packing List.....	2
2.2 Device Description	3
3 Basic Operation	5
3.1 Starting and Shutdown	5
3.1.1 Manual Starting and Shutdown	5
3.1.2 Auto Shutdown.....	5
3.2 Configuring the Camera.....	5
3.2.1 Menu Description	5
3.2.2 Image Adjustment.....	6
3.2.2.1 Adjusting Diopter	6
3.2.2.2 Adjusting Focus	6
3.2.2.3 Setting Color Palettes.....	7
3.2.2.4 Setting Digital Zoom.....	9
3.2.2.5 Setting Status Bar Display.....	9
3.2.2.6 Adjusting Brightness	10
3.2.2.7 Setting Contrast.....	10
3.2.3 Setting Scene Mode.....	10
3.2.4 Setting Burning Warning.....	10
3.2.5 Setting Logo Display.....	11
3.2.6 Setting Language	11
3.2.7 Setting Ranging Mode.....	11
3.2.8 Setting FFC Mode.....	12
3.2.9 Setting DPC.....	12
3.2.10 Setting Hot Point.....	13
3.2.11 Setting Wi-Fi Connection	13
3.2.12 System Settings	14
3.3 Video and Snapshot	15
3.3.1 Recording Videos.....	15
3.3.2 Capturing Images	15

3.3.3 Exporting File	15
3.4 Charging	15
4 System Update	17
4.1 Upgrading Manually	17
4.2 Upgrading through App	17
Appendix 1 Compliance Notice	18

1 Product Introduction

1.1 Overview

The thermal monocular camera captures sharp thermal imaging at a fast frame rate for smooth, impeccable vision on running targets and from moving vehicles. Designed to increase situational awareness at any time of day, the camera can detect humans, animals, and objects in complete darkness, haze, or through glaring light, equipping law enforcement professionals, hunters, and outdoor enthusiasts with reliable thermal imaging in tough conditions. It is widely used in outdoor scenarios for hunting, rescue, animal observation, and more.

1.2 Functions

- Color palettes
Different color palettes display different effects.
- Digital zoom
Supports 1×, 2×, 4× and 8× digital zoom. The number might differ depending on devices.
- Range measurement
Marks the top and bottom of the target, and the screen automatically displays the distance of the target from the camera.
- Hot point tracking
Detects and marks the highest and lowest temperature point.
- Network
Supports network connection through the Wi-Fi. You can add the Camera through mobile app to realize functions, such as capturing, recording and parameter configuration.
- Storage
Built-in storage (32 GB EMMC), supports recording and capturing.
- Automatic suspend and shutdown
Supports setting time of automatic suspend and shutdown.

2 Structure

2.1 Packing List

Figure 2-1 Packing list

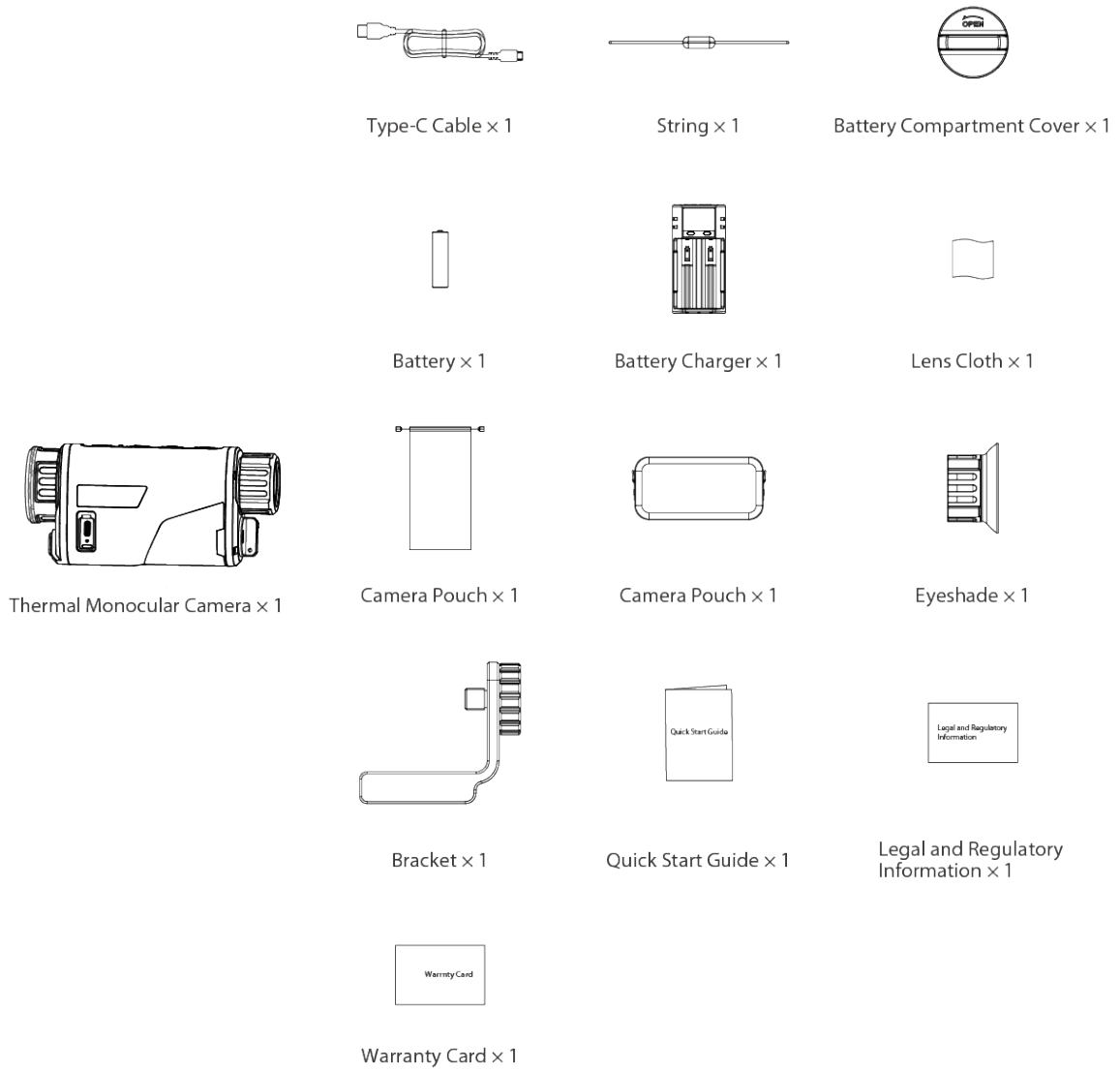

2.2 Device Description

Figure 2-2 Button description

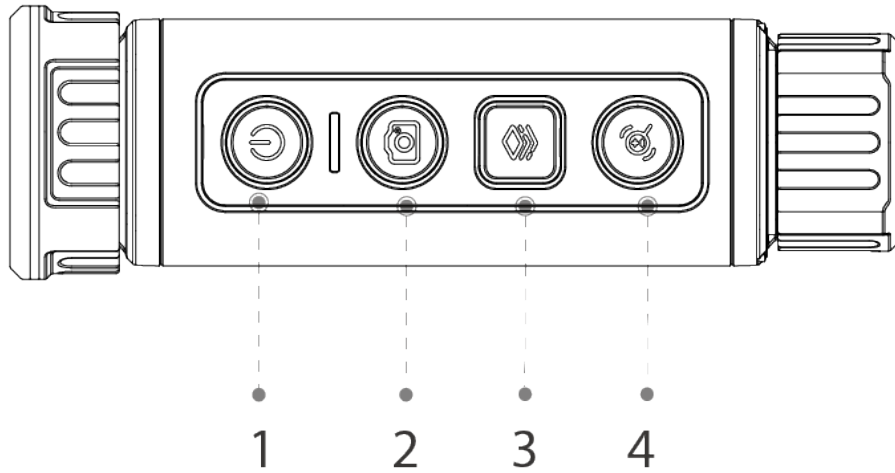

Table 2-1 Button description

No.	Name	Description
1	Power button	<ul style="list-style-type: none"> Press and hold to start or shut down the Camera. Press to enable or disable the suspend mode.
2	Capture button	<ul style="list-style-type: none"> Press and hold to record videos. Press to capture images.
3	Mode button	<ul style="list-style-type: none"> Press and hold to go to the main menu. Press to select the pseudo color.
4	Zoom button	<ul style="list-style-type: none"> Press and hold to manually adjust the shutter. Press for digital zoom.

Figure 2-3 Port description

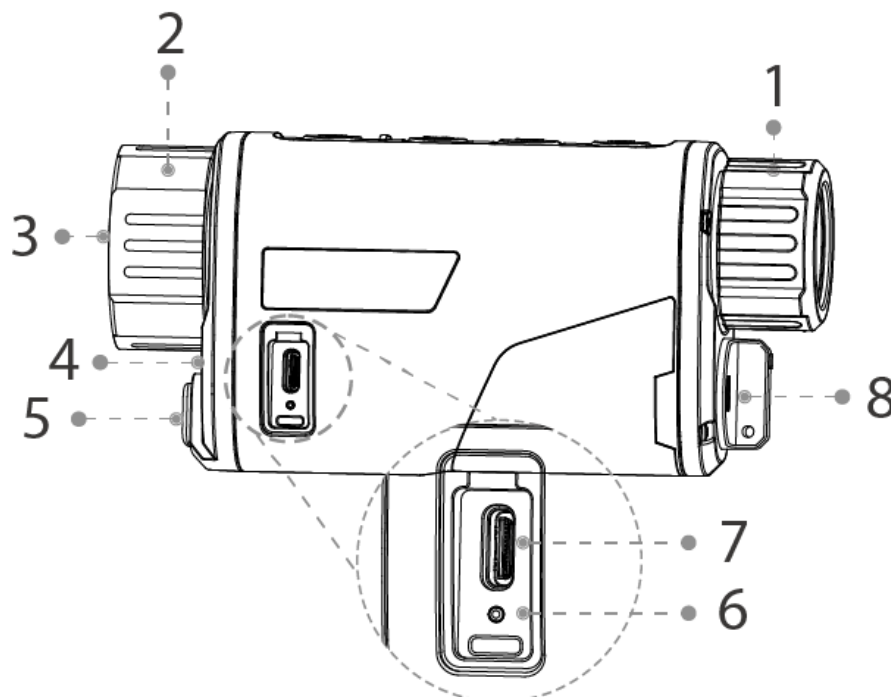



Table 2-2 Port description

No.	Name	Description
1	Diopter adjustment knob	Adjust the diopter according to your eyesight.
2	Adjustable lens	Manually rotate the lens to adjust the focus for a clear image.
3	Protective cover	Dust prevention. Close the cover when not using the Camera.
4	MIC	Collects sound.
5	Tripod nut	For tripod installation.
6	Charging indicator	<ul style="list-style-type: none">• Red and green lights flashing alternately: charging error.• Red light on: charging.• Green light on: fully charged.• Off: not connected to data cable to charge.
7	Type-C port	Connects to a data cable for charging.
8	Battery compartment	The place for holding the battery.

3 Basic Operation





3.1 Starting and Shutdown

3.1.1 Manual Starting and Shutdown

Press and hold  to start or shut down the Camera; press  to suspend or weak up the Camera.



After starting the Camera, remove the protective cover of the lens.

- When the Camera is shut down, press and hold  to start it.
- When the Camera is on, press and hold  to shut down it.
- When the Camera is on, press  to suspend the Camera.
- When the Camera is in suspend mode, press  to weak up it.

3.1.2 Auto Shutdown

Step 1 Press and hold  to go to the main menu.

Step 2 Press  or  to select .

Step 3 Press  to go to the **System Settings** configuration screen.

Step 4 Press  or  to select **Auto Shutdown**.

Step 5 Press , and then press  or  to set the auto shutdown time.

- Off: Disable the auto shutdown.
- 5 Mins, 10 Mins, 30 Mins, 60 Mins: If there is no operation in the configured time, the Camera will automatically shut down.

Step 6 Press  to save the configuration.

After finishing the auto shutdown settings, the Camera will suspend first, and then shut down.

3.2 Configuring the Camera

3.2.1 Menu Description

When the Camera is on, press and hold  to enter the main menu. Function of all buttons are as follows.





- Press  to move upward the cursor.
- Press  to move downward the cursor.
- Press  to confirm.
- Press  to exit.

Figure 3-1 Menu description



3.2.2 Image Adjustment

3.2.2.1 Adjusting Diopter

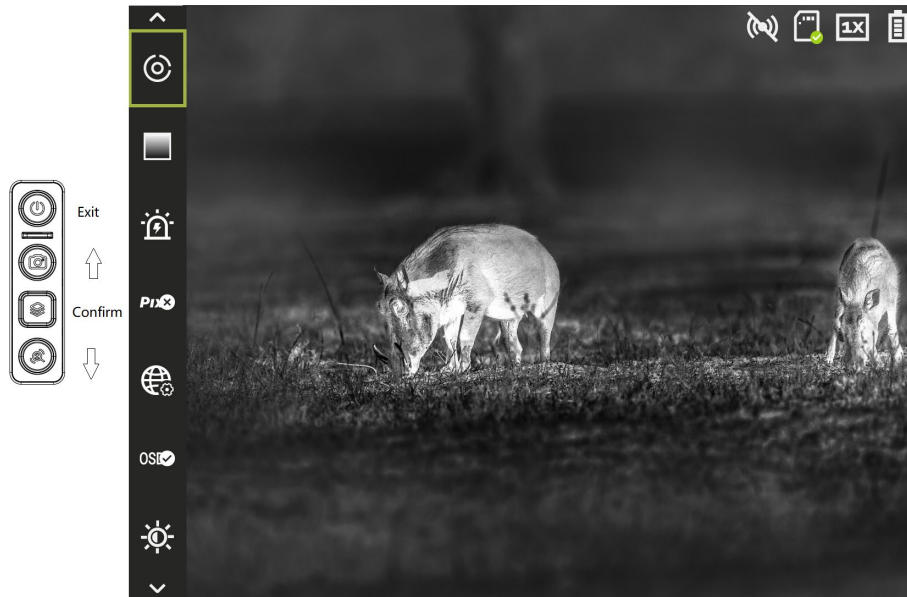
To get clear images, rotating the diopter adjustment knob to fit your eyesight.



For the first-time use, adjust the diopter before configuring the functions.

- Step 1 Aim the lens at the target, and then make your eyes close to the eyeshade.
- Step 2 Adjust clockwise or counterclockwise the knob according to your eyesight.

Figure 3-2 Adjust diopter

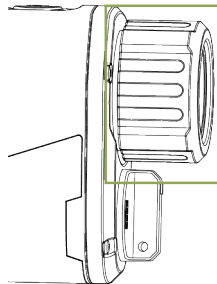

3.2.2.2 Adjusting Focus

Rotate the lens to get a clear view.

- Step 1 Aim the thermal lens to the target.
- Step 2 Adjust clockwise or counterclockwise the lens until the view is clear.



During the adjustment, do not touch the lens to avoid smudging it; otherwise it may affect the image quality.

Figure 3-3 Adjust focus (25 mm&35 mm)

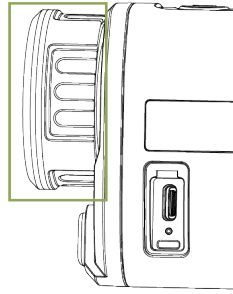

3.2.2.3 Setting Color Palettes

Select the color palettes, which adds color to the thermal image and uses color to indicate the temperature.

On the viewing screen, press  to select the color palettes.



You can also select the  on the main menu to select the color palettes.

- White Hot: The objects with high temperature are white. The higher the temperature, the brighter the color.
- Alarm: The objects with high temperature are red. The objects can stand out.
- Iron Red: The objects with high temperature are red. The higher the temperature, the brighter the color.
- Black Hot: The objects with high temperature are black. The higher the temperature, the darker the color.
- Sepia: The objects with high temperature are brown. The higher the temperature, the darker the color.
- Green Hot: The objects with high temperature are green. The higher the temperature, the darker the color.

Figure 3-4 White hot



Figure 3-5 Alarm



Figure 3-6 Iron red



Figure 3-7 Black hot



Figure 3-8 Sepia



Figure 3-9 Green hot





3.2.2.4 Setting Digital Zoom

Digital zoom helps to zoom in the image.

On the viewing screen, press  to do digital zoom, and the image changes.

3.2.2.5 Setting Status Bar Display

Step 1 On the main menu, press  or  to select .

Step 2 Press  to go to the **Status Bar** configuration screen.









Step 3 Press  to select **On** to display the status bar; select **Off** to hide the status bar.

Table 3-1 Description of status bar



Icon	Name	Description
	Wi-Fi	<ul style="list-style-type: none">: Wi-Fi is disabled.: Wi-Fi is enabled.

Icon	Name	Description
	SD card status	<ul style="list-style-type: none"> • White icon: SD card is correctly installed. • Red icon: The memory of the SD card is full. • Red icon with "X" mark: The SD card is not installed. • Red icon with "!" mark: The SD card runs into fault. The screen displays formatting prompt.
	Digital zoom	Supports 1×, 2×, 3× and 4× digital zoom. The number might differ depending on models.
	Battery level:	Displays the battery level in real time.

Step 4 Press  to save the configuration.

3.2.2.6 Adjusting Brightness

You can adjust the screen brightness, including 5 levels: level 1, level 2, level 3, level 4 and level 5.

Step 1 On the main menu, press  or  to select .



Step 2 Press  to go to the **Brightness** configuration screen.

Step 3 Press  to select the brightness level.

Step 4 Press  to save the configuration.

3.2.2.7 Setting Contrast

You can set the contrast, including 5 levels: level 1, level 2, level 3, level 4 and level 5.



Step 1 On the main menu, press  or  to select .

Step 2 Press  to go to the **Contrast** configuration screen.

Step 3 Press  to select the contrast level.

Step 4 Press  to save the configuration.

3.2.3 Setting Scene Mode

Step 1 On the main menu, press  or  to select .



Step 2 Press  to go to the **Scene Mode** configuration screen.

Step 3 Press  to select the scene mode from **Standard** and **Forest**.

- Standard: Used for daily observation.
- Forest: Stands out the targets with high temperature, which makes it easier to find out the targets.

Step 4 Press  to save the configuration.

3.2.4 Setting Burning Warning







Step 1 On the main menu, press  or  to select .

Step 2 Press  to go to the **Burning Warning** configuration screen.

Step 3 Press  to enable or disable the burn warning function.







Step 4 Press  to save the configuration.

3.2.5 Setting Logo Display

- Step 1 On the main menu, press  or  to select .
- Step 2 Press  to go to the **Logo** configuration screen.
- Step 3 Press  to enable or disable logo display.
- Step 4 Press  to save the configuration.
- After enabling logo display, the logo will be display when the camera is starting.

3.2.6 Setting Language

You can select the language as needed.







- Step 1 On the main menu, press  or  to select .
- Step 2 Press  to go to the **Language** configuration screen.
- Step 3 Press  to select the language as needed.
- Step 4 Press  to save the configuration.

3.2.7 Setting Ranging Mode

After setting the ranging mode, the Camera can measure the range towards targets.



To guarantee the measurement accuracy, keep your hand steady when measuring the range.

- Step 1 On the main menu, press  or  to select .
- Step 2 Press  to go to the **Ranging Mode** configuration screen.
- Step 3 Press  or .to move the green lines to the top and bottom of the target to get the distance between the target and the Camera.

Use the following fig as an example:

- If the target is a wolf, it is 30 m away from Camera.
- If the target is a rabbit, it is 11 m away from Camera.
- If the target is a wild boar, it is 33 m away from Camera.
- If the target is a deer, it is 48 m away from Camera.

Figure 3-10 Ranging mode

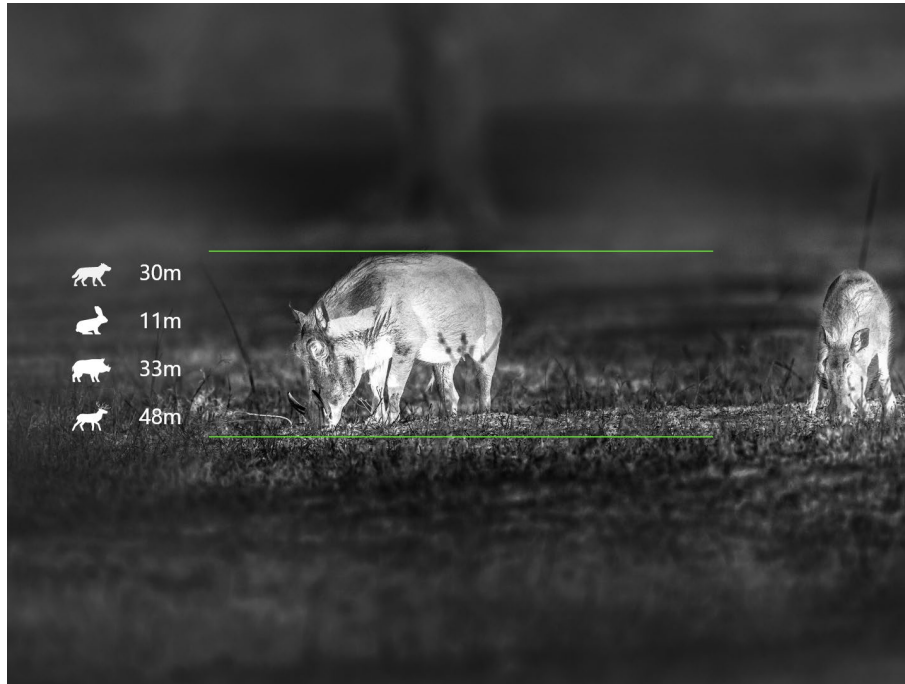

3.2.8 Setting FFC Mode

With FFC (Flat-Field Calibration), the thermal image can be optimized, and you can easily find out temperature changes.

Step 1 On the main menu, press or to select .

Step 2 Press to go to the **Calibration** configuration screen.

Step 3 Select the FFC mode.

- Auto: The camera calibrates image automatically every certain period.
 1. Press to select **Auto**.
 2. Press to confirm.

The camera calibrates image automatically.
- Manual: On the viewing screen, press to manually calibrate the image as needed
- Immediately: Calibrate the image once.
 1. Press to select **Immediately**.
 2. Press to confirm.

The camera calibrates image once immediately.

3.2.9 Setting DPC





After enabling DPC (Defective Pixels Correction), you can correct the defective pixels in the image.

Step 1 On the main menu, press or to select .

Step 2 Press to go to the **DPC** configuration screen.

Step 3 Press to set DPC.

- Auto: The Camera automatically corrects the defective pixels in the image.
 1. Select **Auto**.
 2. Press to start the auto correction.
 3. Follow the screen instructions to close the lens cover.

4. Press  to save the configurations.
- Manual: You need to correct the defective pixels manually.
 1. Press  to select X-axis and Y-axis.
 2. Press and hold  or  to calibrate the defective pixels.
 3. Press and hold  to save the configuration.





The center of the cursor is the position of the defective pixel.

- Restore: The DPC configuration is restored to the primary state.

3.2.10 Setting Hot Point

Tracks the points with the highest and lowest temperature in real time.

Step 1 On the main menu, press  or  to select .

Step 2 Press  to go to the **Hot Point** configuration screen.

Step 3 Press  to enable or disable **Hot Point**.

Step 4 Press  to save the configuration.

After enabling **Hot Point**, the hot and cold point icons will automatically locate at the points with the highest temperature in the image.

3.2.11 Setting Wi-Fi Connection

After enabling Wi-Fi connection, you can connect your phone to the hotspot of the Camera, and then access the Camera with the app.

The frequency bands and modes and the nominal limits of transmitted power (radiated and/or conducted) applicable to this radio device are the following:

Wi-Fi 2.4 GHz (2.4 GHz to 2.4835 GHz)	20 dBm
---------------------------------------	--------



Some cameras will automatically disable the Wi-Fi function when the battery level is lower than 15%.

Step 1 Scan the QR code with your smart phone to install the app.



Figure 3-11 QR code

iOS



Android



Step 2 On the main menu, press  or  to select .

Step 3 Press  to go to the **WiFi** configuration screen.

Step 4 Enable the Wi-Fi function.

- Hotspot: Use the Camera as the hotspot, and connect your phone to the hotspot of the Camera.
 1. Press to select **Hotspot**, and then press .
 2. Enable the Wi-Fi of your smart phone, and then connect to the hotspot of the Camera.
 - ◇ Wi-Fi name: Model number + serial number.
 - ◇ Wi-Fi password: The last 8 digits of the serial number.
-
- You can find the serial number on the Camera and the label of the packing box.
3. Log in to the app. The password is the last 8 digits of the serial number. Add devices according to the prompt.
- Off: Disable the Wi-Fi function.

3.2.12 System Settings

- Step 1** On the main menu, press or to select .
- Step 2** Press to go to the **System Settings** configuration screen.
- Step 3** Press or to select the parameter to be configured.
- Step 4** Press to go to the configuration screen.

Table 3-2 System settings

Parameter	Description
MIC	Press or to enable or disable MIC.
Auto Standby	Press or to select the auto standby time. <ul style="list-style-type: none"> • Off: Disable auto standby. • 1 Min, 3 Min, 5 Min, 10 Min: If there is no operation in the configured time, the Camera will automatically suspend.
USB Mode	Press or to select the USB mode. <ul style="list-style-type: none"> • On: The Camera can be used as a storage device. • Off: Charge the Camera.
Unit Set	Press or to select the unit from meter and feet.
Always On Display	Press or to select On . If there is no operation within a certain period, the screen will be off automatically.
Time Display	Press or to select the display format of the time.
Time Set	Press to select the date or time to be configured; and then press or to set the value.
Version	View the device information such as serial number and version number.
Restore Default	Restore the device to default configuration. This operation will restore the camera to default configuration. Please be careful.

3.3 Video and Snapshot

3.3.1 Recording Videos

On the viewing screen, press and hold  for 3 seconds to start recording a video. The recording icon flashes on the screen and the recording time is display.

Press and hold  again for 3 seconds to stop the recording. When the recording stops, the recording time will display normally.

3.3.2 Capturing Images

On the viewing screen, press  to capture images.

The screen will display an icon when the capturing succeeds.

3.3.3 Exporting File

Exports the recorded and captured files.

Step 1 Connect the Camera to the computer through USB data cable.

The driver will automatically be installed for first-time connection.



- Connect the cables before starting the Camera. Do not hot swap the USB port of the Camera.
- Select **On** on the **USB Mode** configuration screen after connecting the Camera to the computer.

Step 2 On the computer desktop, double-click **My Computer**, and then open the Camera disk at a mobile storage device.

Step 3 Select the files to export and copy them to the computer.

The specific computer client is required for playing the exported files.

Step 4 Disconnect the USB data cable with the computer.

After connecting the Camera to the computer, images can be displayed on the Camera, but the functions of recording and capturing will not be available.

3.4 Charging

The start bar will display battery information after the Camera starts. When the battery is low, charge the Camera timely to make sure the normal function.

- When charging the Camera, the temperature is required at 0 °C to 45 °C (32 °F to 113 °F).

Otherwise the charging function will be automatically disabled.

- Charge the Camera with the Type-C data cable that comes with the delivery.

Step 1 Open the sealing cover of the Type-C port when charging.

Step 2 Connect the Type-C cable to the Type-C port to charge the Camera.







The charging indicator states:

- Red and green lights flashing alternately: charging error.

- Red light on: charging.
- Green light on: fully charged.
- Off: not connected to data cable to charge.

4 System Update

4.1 Upgrading Manually

- Step 1 On the main menu, press  or  to select .
- Step 2 Press  to go to the **System Settings** configuration screen.
- Step 3 Press  or  to select **USB Mode**, and then press .
- Step 4 Select **On**.
- Step 5 Connect the Camera and your computer, and then copy the upgrading file to the Camera.
- Step 6 Disconnect the Camera and your computer, and then restart the Camera.

4.2 Upgrading through App

When the app detects new program for upgrading, it will prompt a notification. Tap **Upgrade** to upgrade the system.

Appendix 1 Compliance Notice

The thermal series products might be subject to export controls in various countries or regions, including without limitation, the United States, European Union, United Kingdom and/or other member countries of the Wassenaar Arrangement. Please consult your professional legal or compliance expert or local government authorities for any necessary export license requirements if you intend to transfer, export, re-export the thermal series products between different countries.